

MODEL VARIATION



MAIN SPECIFICATIONS

Model		8FG10 8FD10	8FG15 8FD15	8FG18* 8FD18*	8FGK20* 8FDK20*	8FG20 8FD20	8FGK25* 8FDK25*	8FG25 8FD25	8FGK30* 8FDK30*	8FG30 8FD30	8FGJ35 8FDJ35
Engine Model		4Y 1DZ-II	4Y 1DZ-II	4Y 1DZ-II	4Y 1DZ-II	4Y 1DZ-II, 2Z	4Y 1DZ-II	4Y 1DZ-II, 2Z	4Y 1DZ-II	4Y 1DZ-II, 2Z	4Y 1DZ-II, 2Z
Load Capacity	kg	1,000	1,500	1,750	2,000	2,000	2,500	2,500	3,000	3,000	3,500
Load Center	mm	500	500	500	500	500	500	500	500	500	500
Overall Width	A mm	1,045	1,070	1,070	1,155	1,150	1,155	1,150	1,255	1,240	1,290
Turning Radius(outside)	B mm	1,910	1,990	2,010	2,040	2,200	2,090	2,280	2,130	2,430	2,490
Overhead Guard Height	C mm	2,080	2,080	2,080	2,085	2,110	2,085	2,110	2,085	2,170	2,180
Length to Fork Face	D mm	2,245	2,290	2,315	2,380	2,560	2,445	2,635	2,520	2,795	2,865

NOTE: *Powershift models

ENGINE SPECIFICATIONS

Model		TOYOTA 4Y Gasoline
Piston Displacement	cc	2,237
Rated Power/r.p.m.	kW	40/2,400 (43/2,600)
Rated Torque/r.p.m.	N-m	162/1,800

NOTE: () for 30(32)-8FG30.8FGJ35

Model		TOYOTA 1DZ-II Diesel	TOYOTA 2Z Diesel
Piston Displacement	cc	2,486	3,469
Rated Power/r.p.m.	kW	40/2,400 [44/2,600]	49/2,200
Rated Torque/r.p.m.	N-m	167/1,600	216/1,600

NOTE: [] for 60(62)-8FD20.25.30.J35

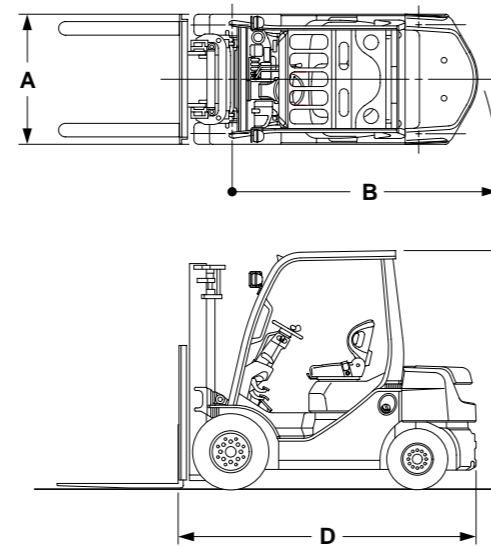

The data in this brochure is determined based on our standard testing condition.
The performance may vary depending on the actual specification and condition of the vehicle as well as the condition of the operating area.
Availability and specifications depend on region and are subject to change without notice.
Due to photography and printing, color of actual vehicle may vary from this brochure. Some photos have been computer-enhanced.
Please consult your Toyota representative for details.

All rights reserved by Toyota Industries Corporation.



TOYOTA MATERIAL HANDLING INTERNATIONAL



The Mastery of True Potential

Mastery of any undertaking can only be achieved if there is true potential and unwavering dedication to excellence. To Toyota, the 8 Series is the proud culmination of 50 years in the pursuit of mastery in the development and manufacture of forklifts.

All who experience the level of mastery in the 8 Series will be inspired to reach for higher goals.

Here, Toyota integrated outstanding comfort and excellent operability into a operator's compartment that realizes operator friendliness. The 8 Series is also equipped with high technology that contributes to the creation of a safe workplace.



Features and equipment may vary depending on market.

Outstanding Comfort and Visibility

The 8 Series provides the comfort and visibility for long hours of efficient operation.

Efficiency-Boosting Operability

The operator's compartment is carefully designed to ensure maximum forklift control from minimum operator effort.

Top-Class Stability

Toyota's System of Active Stability (SAS), Operator Presence Sensing (OPS) system and Travel and Load Handling Control provide innovative, high-tech stability to the 8 Series.

Environmental Friendliness

Low noise and exhaust emissions make the 8 Series environmentally friendly.

Built-in Reliability and Serviceability

Designed to be tough and easy to maintain.

True Potential Through Outstanding Comfort and Visibility

Comfort is a Toyota tradition. With the 8 Series, it starts from the time you enter. Grab the large assist grip, place your foot on the wide, low step and slide into the operator's seat that provides comfort, support and retention. Once you have been seated and wrapped your hands around the small-diameter steering wheel you will intuitively feel that everything you need for operating the forklift is within natural reach. You will also instantly realize that you have a clear view of the forks and load. This comfort sets the stage for reaching the true potential of the forklift from Toyota.



Features and equipment may vary depending on market.



Easy Entry and Exit

A large assist grip, A deep, wide step and a spacious opening team up for easy entry onto the forklift.



Comfort and Support ORS* Seat



The ORS seat can be adjusted 150 mm forward and backward to provide comfort and support to almost all sizes of operators. *ORS: Operator Restraint System

Wide Floor Space



The spacious floor area enables a more relaxed operating position that contributes to comfort.

Outstanding Visibility



The overhead guard, mast and instrument panel have been designed to provide excellent visibility of the fork tips at the most frequently used lift heights.

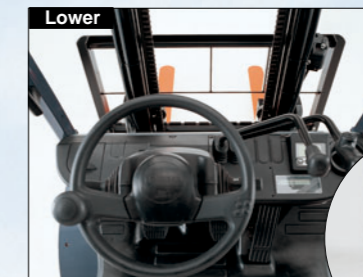

True Potential Through Outstanding Operability

Toyota used the latest technology to reexamine forklift operation in its search for enhanced operability. Motion-capture technology monitored every aspect of operator movement looking for ways to make operation more efficient. Based on these findings, well-thought-out design changes were combined to make the 8 Series ready to transform every action of the operator into smooth and efficient operation.

Operator-Friendly Steering Wheel



The small-diameter steering wheel teams up with the full hydraulic power steering system to provide excellent maneuverability. The steering column offers step-less adjustment to accommodate a wide range of operator preferences.

Foot-Activated Parking Brake (Powershift models)

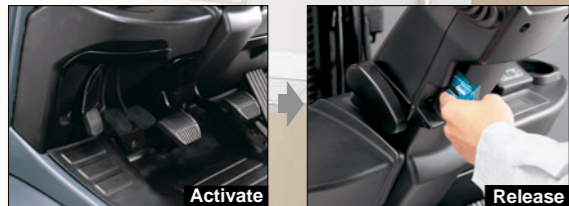

The operator simply depresses the parking brake pedal to set it without changing operating position. A conveniently located handle is used to release it.

Rear-Pillar Assist Grip OPT / Swivel Seat OPT



The seat swivels to the right to facilitate operation in reverse. The seat also swivels to the left to make it easier to enter and exit the forklift.

An optionally available rear-pillar assist grip with a horn button enhances comfort by offering easy horn operation while traveling in reverse.



Features and equipment may vary depending on market.

Multifunction Display OPT

The Multifunctional Display offers useful information for operations. The following are some of the display screens.



Combination Meter

Necessary instrumentation, such as the fuel meter, water temperature indicator and hour meter are shown in an easy-to-monitor digital format.

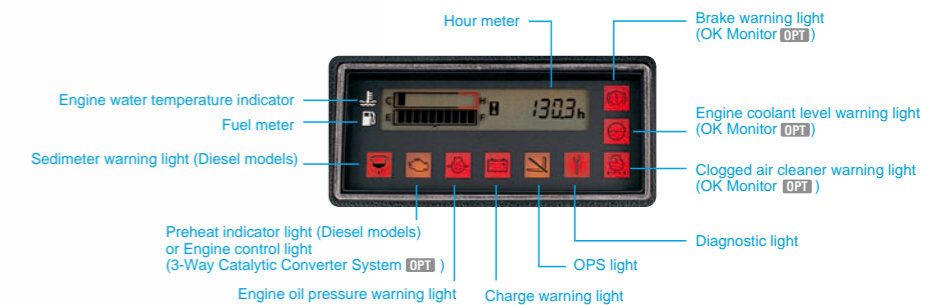

Mini Lever OPT

These small, easy-to-operate levers provide total load handling operation and travel direction selection. A fatigue-reducing armrest is provided.

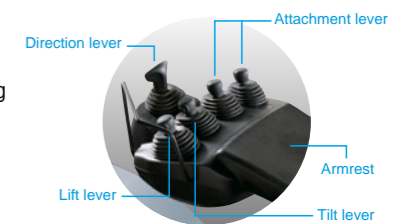

Joystick OPT

Both lift and tilt operations are controlled by a single lever. Simultaneous lifting and tilting can be operated.

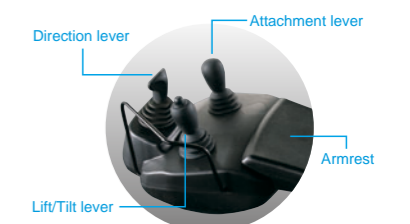

Fork Vibration Damper OPT

Shock and vibration to the load during load handling and travel are suppressed by an accumulator in the hydraulic circuit for the lift cylinder.



True Potential Through Outstanding Stability

At Toyota, safety is top priority in the quest for attaining true potential. Here, the state-of-the-art technology found in the System of Active Stability (SAS), which earned high praise on the 7 Series, helps to reduce the potential for accidents. Other innovative functions, such as the Operator Presence Sensing System (OPS) and optional Travel and Load Handling Control are ready to assist in protecting the operator and the load. Toyota's continuous efforts toward safety provide you with a solid foundation for outstanding stability.

Active Control Rear Stabilizer **SAS** **OPT**

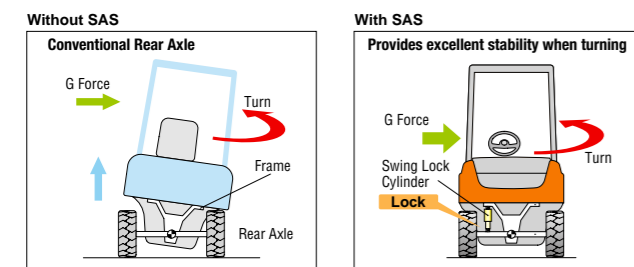

An onboard computer monitors the movement of the forklift and locks the swing of the rear axle when necessary, such as during turns.
Note: The Active Control Rear Stabilizer is not installed when the forklift is originally equipped with optional dual front tires.

Active Steering Synchronizer **SAS** **OPT**

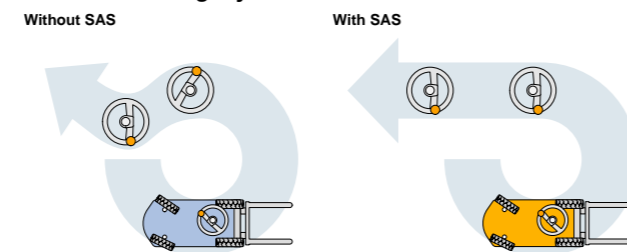

This function ensures that the position of the steering wheel unvaryingly corresponds with the position of the rear steer wheels.

Active Mast Function Controller **SAS** **OPT**

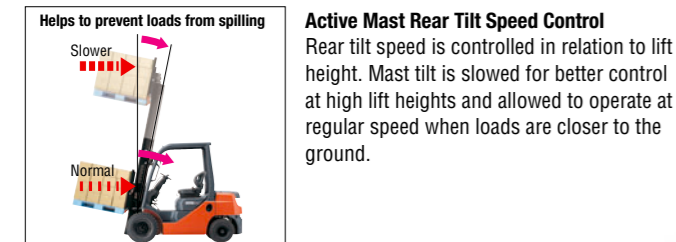

SAS + OPS

System of Active Stability Operator Presence Sensing

Operator Presence Sensing System **OPS**

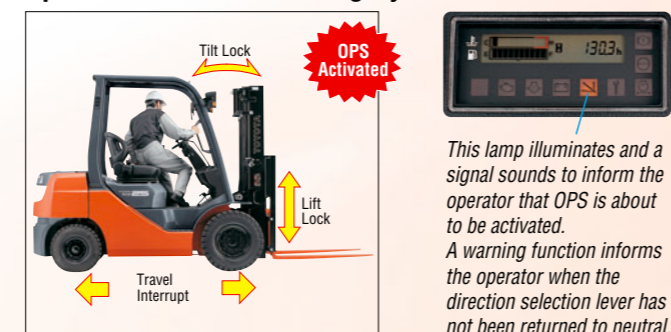

This system uses a switch sensor built into the operator's seat to detect the presence of the operator. If the operator is not in the normal operating position, travel power is interrupted and load handling operations are stopped.
*Note: OPS does not operate the brakes. Always set the parking brake before leaving the forklift.
Travel OPS is not available on manual transmission models.*



Features and equipment may vary depending on market.

3. Low-Speed Setting

This feature limits maximum speed to a preset level when the switch on the Multifunction Display is pressed. This can be useful at locations such as customer worksites that have different speed rules for outdoor and indoor operations.

4. Maximum Speed Limitation

This feature enables to limit maximum speed to a preset level. This helps operators maintain certain speed limits in the work area while freeing them from the need to control acceleration, and also reduces the need for forklift managers to monitor the speed of the forklifts.

5. Automatic Idle-Up Device

The idle revolution of the engine is automatically increased during lifting operations so that loads will be slowly lifted up without depressing the accelerator. It provides easy and proper load handling operation.

The following should be noted in regard to Travel and Load Handling Control. On up grade, the set speed may not be reached due to engine output. Also on down grade, gravity may cause preset speed to be exceeded. Although maximum speed and sudden acceleration are reduced in relation to load height and weight, this does not eliminate the possibility of tip-over. Toyota's advanced technology helps reduce the potential of forklift instability. However, the operator is ultimately responsible for safe operation.

Travel and Load Handling Control **OPT**

1. Lift-Height and Load-Sensing Vehicle Speed Control (Powershift models)

This feature limits the maximum speed if the operator attempts to travel while carrying loads at high lift heights, thereby reducing the likelihood of instability due to sudden deceleration.

2. Lift-Height and Load-Sensing Sudden Start Off Prevention Feature (Powershift models)

This feature suppresses sudden acceleration of the vehicle to reduce the risk of load spills in the event that the operator suddenly depresses the accelerator or operates the direction selection switch while carrying loads at high lift heights.

True Potential Through Outstanding Environmental Friendliness

The 8 Series is easy to get along with. It is specially designed to provide the operator and all those working nearby with a pleasant work environment. Low noise operation, low exhaust emissions and low vibration all mean that the 8 Series will hardly be noticed as it diligently enhances productivity at the workplace. And the 8 Series demonstrates that Toyota is continuing to make progress in eliminating harmful chemicals from the components of its forklifts, making them even more environmentally friendly.

Low-Noise Design

Meet your silent partner. Thick-sealing under the floorboards and the use of sound-absorbing and sound-proofing materials all work together to give the 8 Series low-noise operation.

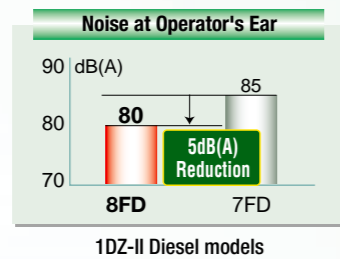
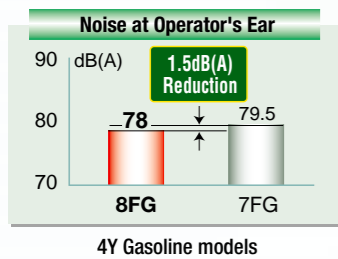

Low-Vibration Design

Carefully designed engine and drive train mounts dramatically reduce the amount of vibration felt at the floorboard and steering wheel.

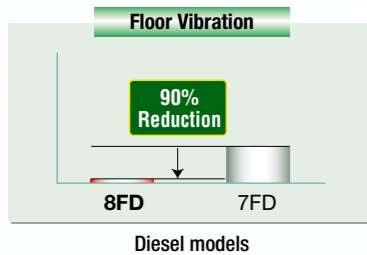
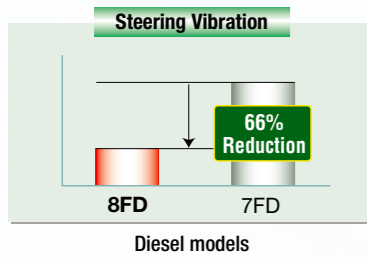

3-Way Catalytic Converter System **OPT**

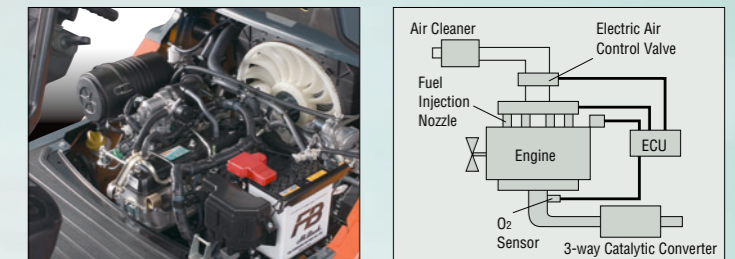

Electronic control is used on the 4Y engine to regulate the fuel injection and ignition systems. This is combined with the 3-Way Catalytic Converter System to filter out carbon monoxide (CO), hydrocarbon (HC) and nitrogen oxide (NOx) gases.

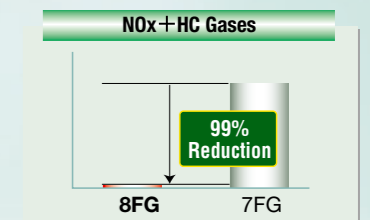
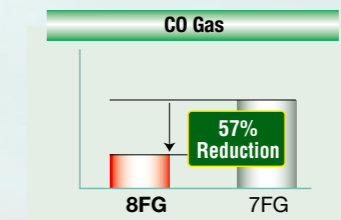

Diesel Particulate Filter DPF-II **OPT**

It uses an enhanced filtering system to provide excellent black smoke particle elimination. The DPF-II provides the additional benefits of easier starting and longer filter life.

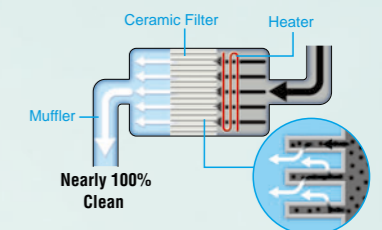

Environmentally Friendly Design

The 8 Series is free of asbestos, mercury and cadmium. The amount of lead and hexavalent chromium has also been dramatically reduced in order to minimize the affect on the environment.

Features and equipment may vary depending on market.

True Potential Through Outstanding Reliability & Serviceability

Reliability is what Toyota forklifts have proven themselves to provide under harsh conditions the world over. This is because Toyota is always committed to boosting reliability. The use of resin parts has been reduced as much as possible along with other steps to enhance durability. The result is a forklift that will offer an extended life.

Serviceability can help boost the reliability of a forklift and extend its service life. The 8 Series has been designed so that anyone can easily inspect it. If service is needed, easy access can help to reduce downtime.



Tilt Cylinder Boots

Each boot covers the exposed portion of the rod for the tilt cylinder, protecting it and the oil seals.

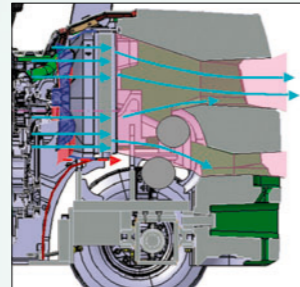

Cooling System

Ample cooling raises reliability by preventing overheating. The size of the opening in the counterweight has been increased to optimize air flow through the engine compartment and power unit.



Water-Resistant Connectors

Connectors for most electrical components are highly water-resistant, increasing the reliability of the electrical system.



Long Life Tire OPT

Wear resistant tires help reduce running costs and provide extended life.



Engine Hood

The wide-opening engine hood provides easy access for inspections or servicing.



Radiator Cover

No tools are needed to remove the radiator cover. The fasteners can easily be turned by hand to enable quick inspections or servicing.



Brake Fluid

Simply lift up the cover on the panel to check the brake fluid.



Hood Latch

The easy-to-operate latch provides quick access to the engine compartment.

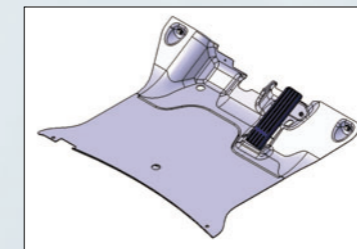

Floorboard

A two-piece design makes the floorboard easier to lift and handle. Remove these two pieces for wide open access to the engine and power train.



Scheduled-Maintenance Hour Warning Indicator (Multifunction Display OPT)

When the set time for maintenance is reached, this feature provides visible and audible notification.



From the Chief Engineer

“What are customers really looking for in a forklift?”

In the development of the 8 Series, we took on the challenge of developing a forklift based on 50 cumulative years of technology with enthusiastic passion as our motivation. We returned to the starting point and took a careful look at the forklift itself from every aspect.

The 8 Series stands ready to bring out the true potential in all owners and operators.



Features and equipment may vary depending on market.



Hisao Nagata
Chief Engineer of the 8 Series,
TOYOTA MATERIAL HANDLING GROUP

During the development of the 8 Series we combined our ongoing quality improvement activities with more than 4,500 customer surveys and this helped us to fully recognize what the current forklift customer needs were, and what those needs would be in the future.

The results lead us to conclude that the best method for satisfying customer needs was to: “investigate the essence of what makes a good forklift by basing our design on the 7 Series and by further infusing Toyota’s strengths into that design.

In continuing our evolution from the 7 Series, we aimed for advances in the areas of safety, ergonomics, cost of ownership and environmental considerations.

In the field of safety we have added a traveling control option in addition to the existing

System of Active Stability (SAS) and Operator Presence Sensing (OPS) features. We have been able to realize this functionality by harmonizing the SAS technology with the optional electronic fuel injection (EFI) system that has been employed in the present design.

This field of ergonomics is inseparably linked to the concept of work efficiency. The ability of the operator to work in comfort is an extremely important factor in dealing with the high speed of the present-day logistics business. By paying close attention to all sizes, shapes and layouts of the operator compartment, we have been able to realize significant improvements in visibility and operator operating space. Through a concerted approach to reducing noise and vibration, we have created a forklift that has significantly reduced noise and vibration levels, as well as minimizing operator fatigue.

Cost of ownership is closely connected with the issue of reliability. As forklifts are a capital good, breakdowns that can stop customer productivity are a worst case scenario. By focusing on the areas of enhancing reliability, reducing downtime through making maintenance easier to perform, and extending maintenance periods, we have developed a forklifts series that is able

to make the greatest contribution to customer profitability.

Environmental factors are central to our thinking. Customers have also expressed a concern for the environment, a concern that we share. We have addressed this by using a multi-pronged approach. In the manufacturing process, we reduced and eliminated the use of materials that are environmentally sensitive. We have also developed a forklift with top-class emissions performance. This will reduce the output of undesirable substances over the lifetime of the truck, while simultaneously creating a cleaner work environment.

While this new design represents an evolution from the 7 Series, the development team began by re-evaluating the designs from scratch. They covered the smallest details – including each screw used in the forklift’s construction – to ensure the development of best-of-breed forklift units that truly satisfy customer needs. I believe we have created a series of forklifts that further enhance the reputation that Toyota has established over the years.

永田尚夫
Hisao Nagata



Development Meeting



Noise Level Testing



Electronic Component Testing

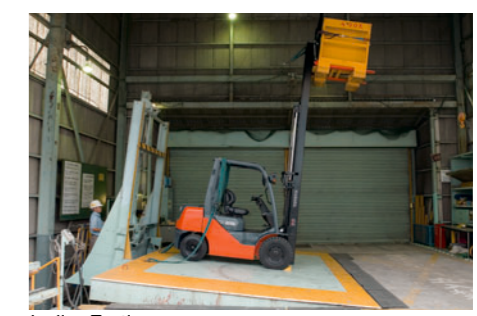

Incline Testing



Water Resistance Testing



Data Sampling

The development and design of the 8 Series was done at the Toyota Takahama Plant in Aichi, Japan. During the development stage, state-of-the-art technology was used to get a better understanding of operator movement during forklift operation. This data was carefully analyzed and used to enhance the design of the 8 Series. Then the 8 Series was exposed to test conditions far harsher than it will ever experience on the job. The result is a remarkable forklift series that will be providing productivity for years and years to come.